



PRODUCT *CATALOGUE*

2023

SHENZHEN LEDWAY LIGHTING CO.,Ltd

Add: 6th floor,Building C,Weijian industrial park,Jintai road NO. 7,Shiyan street,Baoan district,Shenzhen city

COMPANY PROFILE

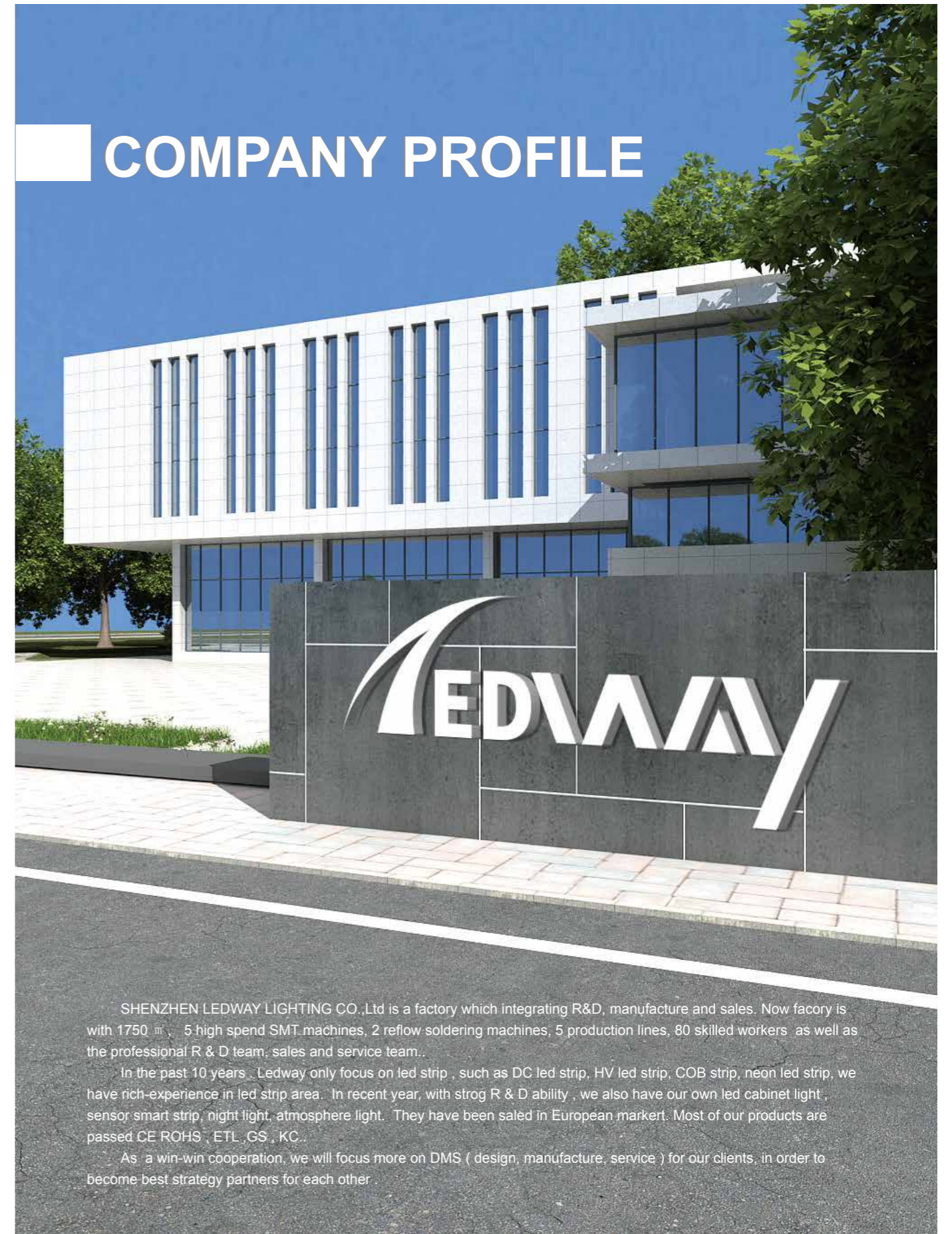

SHENZHEN LEDWAY LIGHTING CO.,Ltd is a factory which integrating R&D, manufacture and sales. Now factory is with 1750 m^2 , 5 high speed SMT machines, 2 reflow soldering machines, 5 production lines, 80 skilled workers as well as the professional R & D team, sales and service team.

In the past 10 years, Ledway only focus on led strip, such as DC led strip, HV led strip, COB strip, neon led strip, we have rich-experience in led strip area. In recent year, with strog R & D ability, we also have our own led cabinet light, sensor smart strip, night light, atmosphere light. They have been saled in European markert. Most of our products are passed CE ROHS, ETL, GS, KC.

As a win-win cooperation, we will focus more on DMS (design, manufacture, service) for our clients, in order to become best strategy partners for each other.

LEDWAY WORKSHOP



CONTENTS →

Led sensor strip	01-02
Led Cabinet light	03-06
Led Ambient Light	07-12
COB Strip	11-25
SMD DC Led Strip	28-40
High Voltage strip	41-46
Neon strip	47-48
Led strip kit	49-64



LED Motion Sensor Strip

www.ledwaylighting.com | jelly@ledwaylighting.com

- Human body and light sensor switch
- Lithium battery for power supply
- Sensor is fixed by using magnet, easy to use
- Apply use android phone charger



LW-GYB



DC 5V
Rechargeable

- 4*AAA BATTERY
- Human body sensor switch

LW-GYC

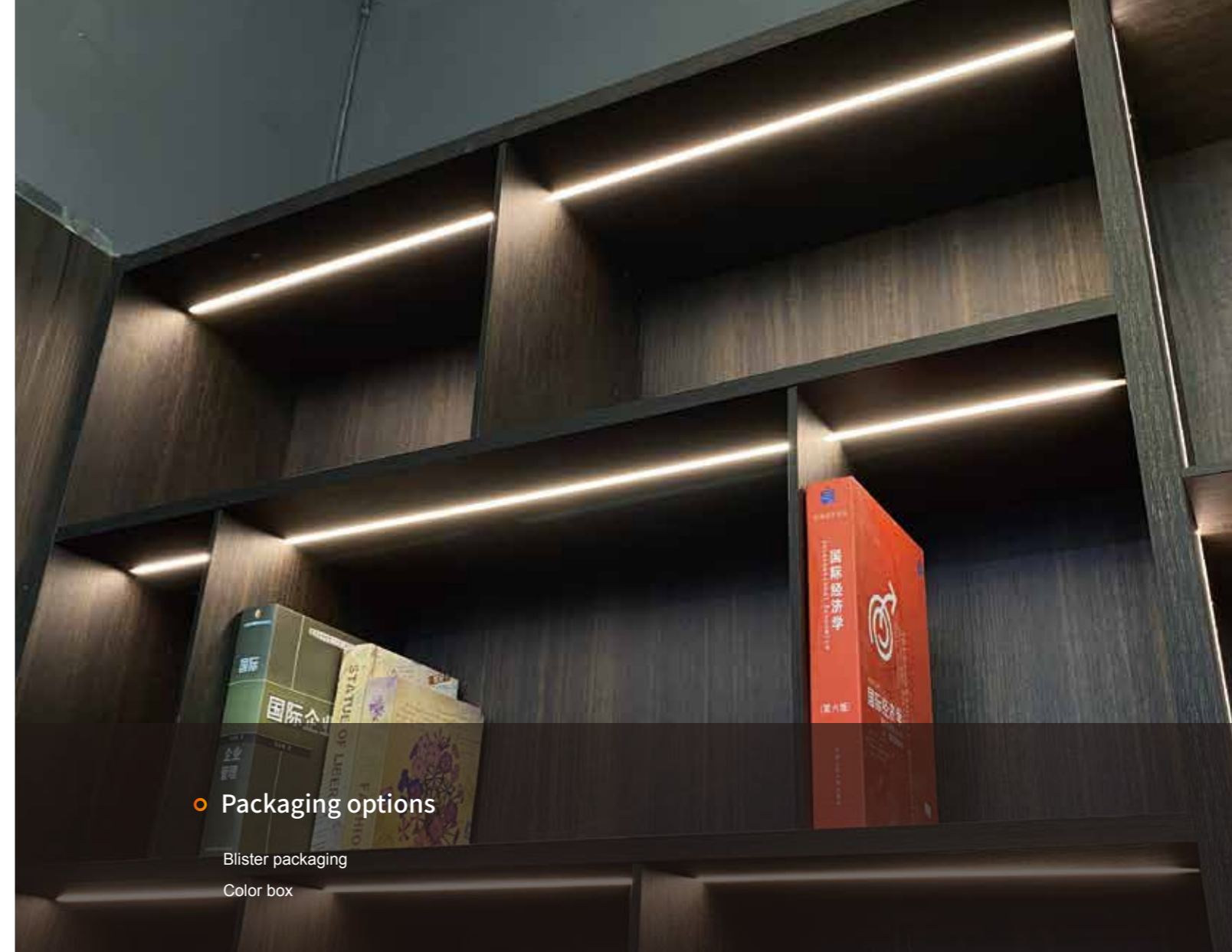

○ Packaging options

- Blister packaging
- Color box

Model	LW-GYB-10	LW-GYB-15	LW-GYB-20	LW-GYC-10
Power Supply	3.7V 1500mAh	3.7V 1800mAh	3.7V 1800mAh	6V (AAA*4)
Power(W/m)	2.2W	3.0W	4.0W	2.2W
Body Material	PC+ABS	PC+ABS	PC+ABS	PC+ABS
Led	SMD2835	SMD2835	SMD2835	SMD2835
Led Qty(LED/m)	30LEDs	30LEDs	30LEDs	30LEDs
Lumen	180lm	250lm	320lm	180lm
CRI(Ra)	>80	>80	>80	>80
CCT	3000K/4000K/6000K	3000K/4000K/6000K	3000K/4000K/6000K	3000K/4000K/6000K
Sensor Distance	0.5~5m	0.5~5m	0.5~5m	0.5~5m
Sensor Angle	100°	100°	100°	100°
Sensor Mode	PIR sensor	PIR sensor	PIR sensor	PIR sensor
Strip length	1m	1.5m	2m	1m
Delay Time	15s/120s/300s	15s/120s/300s	15s/120s/300s	15s
Charging Time	3.5-4.5h	4-5h	4-5h	-
Working Time	>3.5h	>3h	>2h	>2.5h



New LED Floor Atmosphere Light

www.ledwaylighting.com | jelly@ledwaylighting.com



LW-FW-07-150



Model	LW-FW-07-150	LW-FW-07-150(Bluetooth)	LW-FW-07-150(TUYA WIFI)
Voltage	DC5V 2A	DC5V USB	DC5V 2A
Power	10W(MAX)	10W(MAX)	10W(MAX)
Body Material	PP+ABS	PP+ABS	PP+ABS
Led	SMD5050RGB	SMD5050RGB	SMD5050RGB
LED Qty	68LEDS	68LEDS	68LEDS
CCT	RGB+IC	RGB+IC	RGB+IC
way to control	IR remote control	Bluetooth APP	TUYA WIFI APP
size	128*1515mm	128*1515mm	128*1515mm
music mode	YES	YES	YES

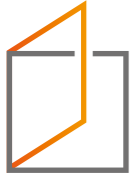

LED Mirror Light

www.ledwaylighting.com | jelly@ledwaylighting.com



L205*W145*H52mm



1.77" / 45cm

1.77" / 45cm



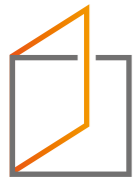

LED Ambient Light

www.ledwaylighting.com | jelly@ledwaylighting.com

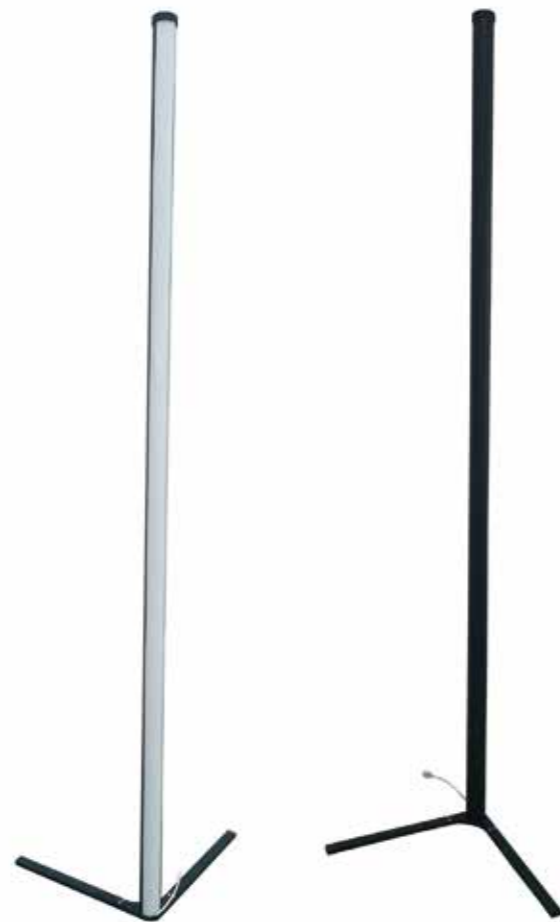

LW-FWA-RGB+IC+W
LW-FWA-RGB+W

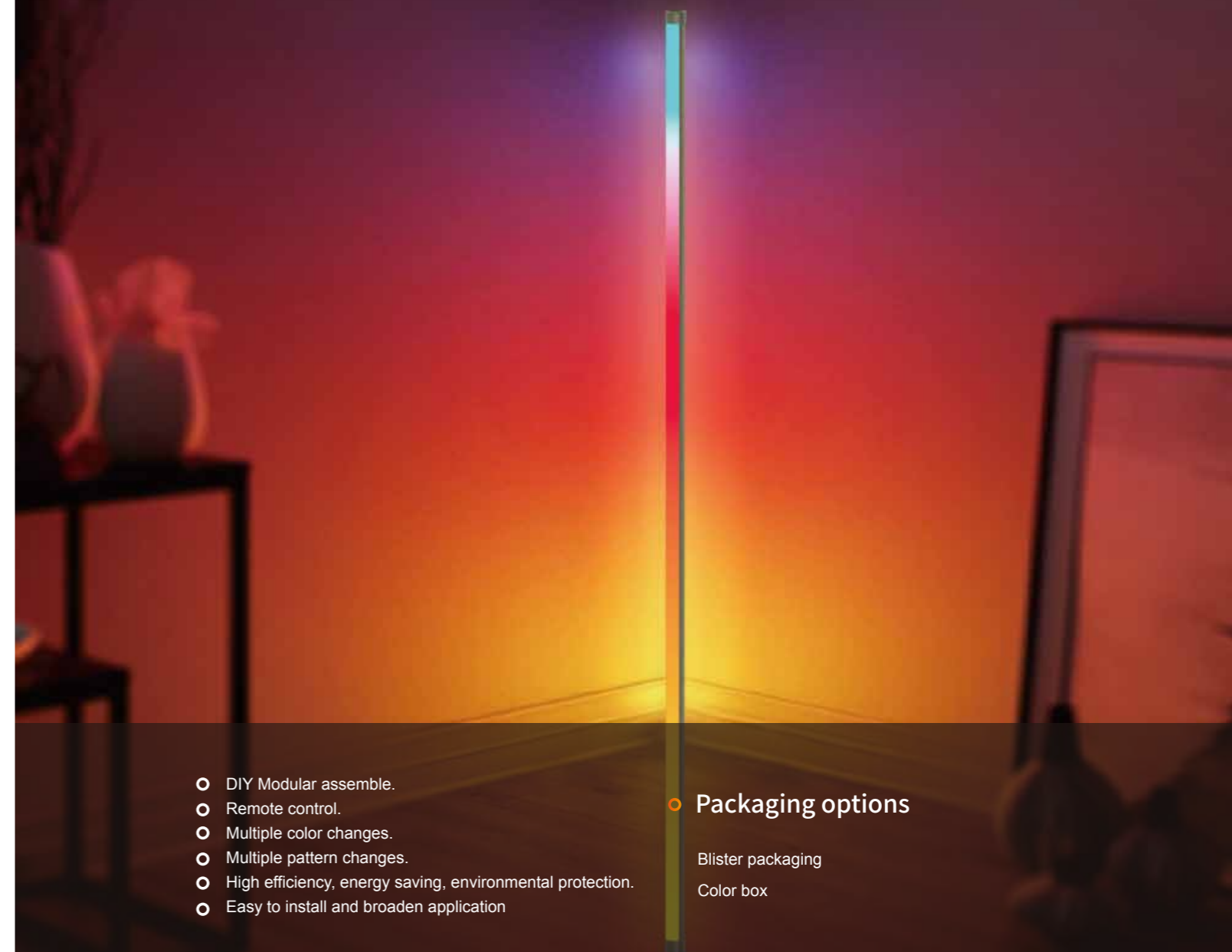

- DIY Modular assemble.
- Remote control.
- Multiple color changes.
- Multiple pattern changes.
- High efficiency, energy saving, environmental protection.
- Easy to install and broaden application

○ Packaging options

- Blister packaging
- Color box

Model	LW-FWA-RGB+IC+W	LW-FWA-RGB+W
Voltage	12V	12V
Power	18W	18W
Body Material	ABS+AL	ABS+AL
Led	5050RGB+2835	5050RGB+2835
Lumen	180lm	180lm
CRI(Ra)	>80	>80
Color	RGB+IC+W	RGB+W



Single Color COB Strip

LW-C312-8W-24V-8F0

Picture



Dimension

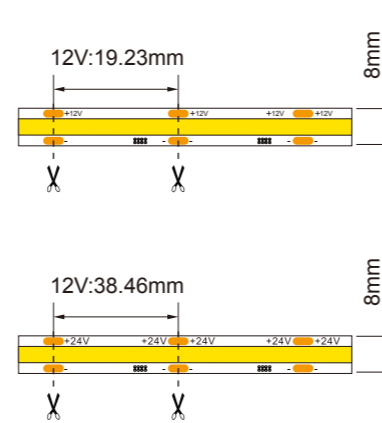

Qualification



Features

- High density COB strip
- Linear lighting, without light spot, soft and uniform luminance
- High CRI, high brightness
- Must used with an aluminum profile for good heat dissipation

Parameters

Model	LW-C312-8W-24V-8F0
Led	SMD COB
Led Qty/m(pcs)	312
Voltage(DC V)	12/24
Power(W/m)	8
CRI(Ra)	>90
Lumen(Lm)	700
PCB Width(mm)	8
Cutting unit(mm)	/
CCT	2700K 3000K 4000K 6500K R G B
IP Grade	IP20 IP65 IP68



Single Color COB Strip

LW-COB320-10W-12/24V-08F0-5M

Picture

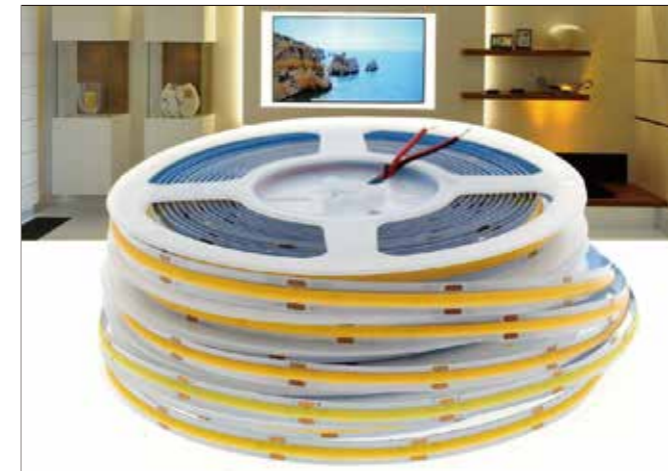

Dimension

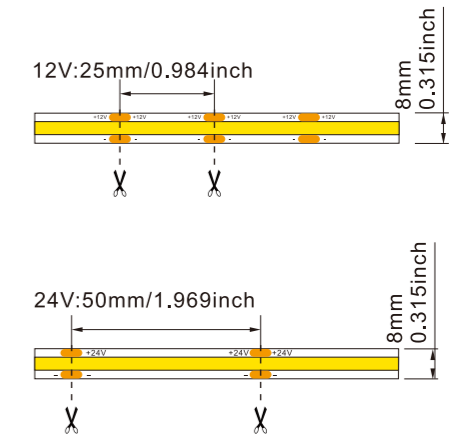

Qualification



Features

- High density COB strip
- Linear lighting, without light spot, soft and uniform luminance
- Cuttable type for different lengths
- High CRI, high light efficiency, low heat dissipation

Parameters

Model	LW-COB320-10W-12/24V-08F0-5M
Led	SMD COB
Led Qty/m(pcs)	320
Voltage(DC V)	12/24
Power(W/m)	10
CRI(Ra)	>90
Lumen(Lm)	800
PCB Width(mm)	8
Cutting unit(mm)	50
CCT	2700K 3000K 4000K 6500K R G B
IP Grade	IP20 IP65 IP68



Single Color COB Strip

LW-C384-10W-24V-8F0

Picture

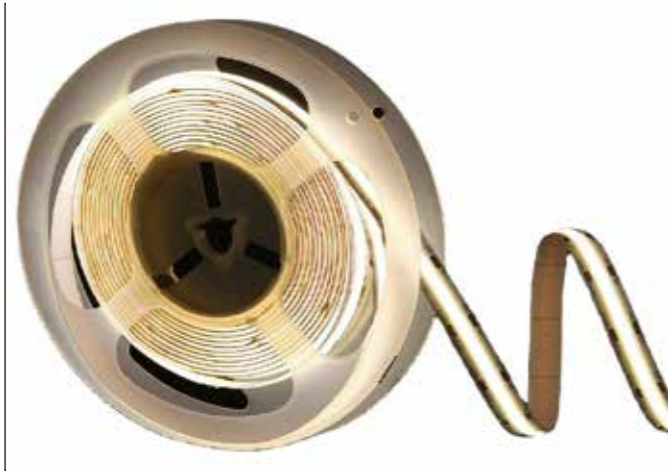

Dimension

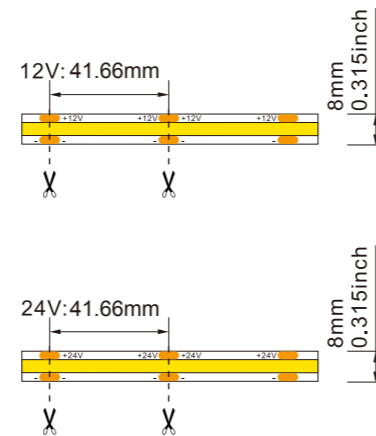

Qualification



Features

- Chips build on flexible PCB board
- High density COB LEDs
- Light dot free without any dark area, uniform light
- High CRI, high brightness and light efficiency, low power consumption

Parameters

Model	LW-C384-10W-24V-8F0
Led	SMD COB
Led Qty/m(pcs)	384
Voltage(DC V)	12/24
Power(W/m)	10
CRI(Ra)	>90
Lumen(Lm)	800
PCB Width(mm)	8
Cutting unit(mm)	/
CCT	2700K 3000K 4000K 6500K R G B
IP Grade	IP20 IP65 IP68



Single Color COB Strip

LW-COB512-12W-12/24V-08F0-5M

Picture



Dimension

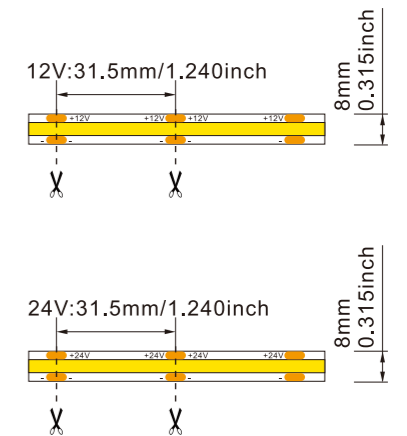

Qualification



Features

- Chips build on flexible PCB board
- High density COB LEDs
- Light dot free without any dark area, uniform light
- High CRI, high brightness and light efficiency, low power consumption

Parameters

Model	LW-COB512-12W-12/24V-08F0-5M
Led	SMD COB
Led Qty/m(pcs)	512
Voltage(DC V)	12/24
Power(W/m)	12
CRI(Ra)	>90
Lumen(Lm)	850/900/1000/1100
PCB Width(mm)	8
Cutting unit(mm)	50
CCT	2700K 3000K 4000K 6500K R G B
IP Grade	IP20 IP65 IP68



Single Color COB Strip

LW-C528-14W-24V-8F0

Picture



Dimension

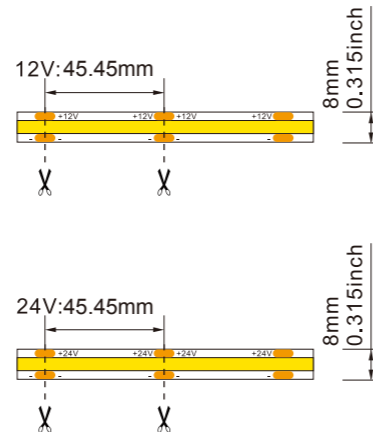

Qualification



Features

- Chips built on flexible PCB board
- High density COB LEDs
- Light dot free without any dark area, uniform light
- High CRI, high brightness and light efficiency, low power consumption

Parameters

Model	LW-C528-14W-24V-8F0
Led	SMD COB
Led Qty/m(pcs)	528
Voltage(DC V)	12/24
Power(W/m)	12
CRI(Ra)	>90
Lumen(Lm)	1000
PCB Width(mm)	8
Cutting unit(mm)	50
CCT	2700K 3000K 4000K 6500K R G B
IP Grade	IP20 IP65 IP68



Single Color COB Strip

LW-COB720-20W-24V-10F0-5M

Picture



Dimension

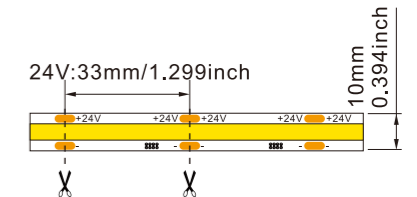

Qualification



Features

- High density COB strip
- Linear lighting, without light spot, soft and uniform luminance
- High CRI, high brightness
- Must used with an aluminum profile for good heat dissipation

Parameters

Model	LW-COB720-20W-24V-10F0-5M
Led	SMD COB
Led Qty/m(pcs)	720
Voltage(DC V)	24
Power(W/m)	20
CRI(Ra)	>90
Lumen(Lm)	1560/1600/1840/2000
PCB Width(mm)	10
Cutting unit(mm)	33
CCT	2700K 3000K 4000K 6500K R G B
IP Grade	IP20 IP65 IP68



RGB COB Strip

LW-COBRGB480-12W-12/24V-12F0-5M

Picture

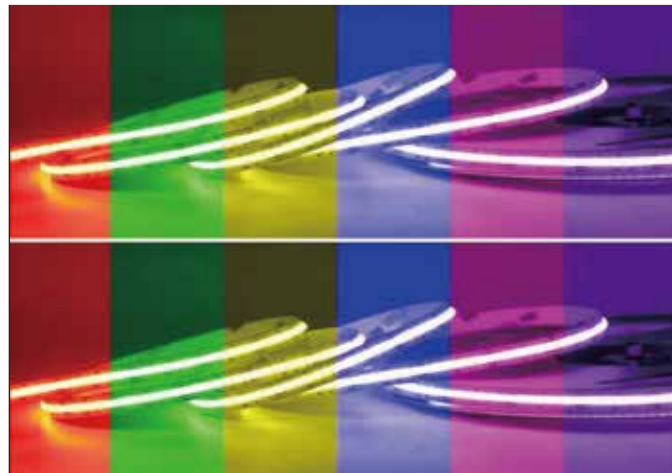

Dimension

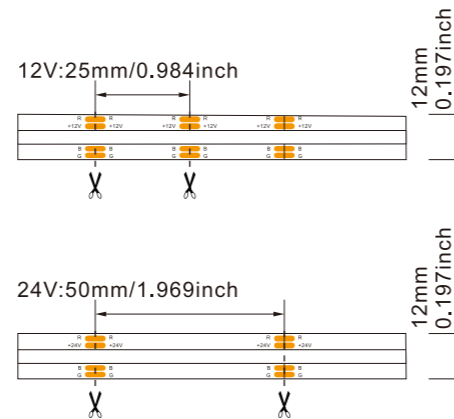

Qualification



Features

- High density COB strip light
- Soft and flexible PCB, easy to install
- Provide RGB colorful lights
- Wildly used as residential lighting and DIY lighting

Parameters

Model	LW-COBRGB480-12W-12/24V-12F0-5M
Led	SMD COB
Led Qty/m(pcs)	480
Voltage(DC V)	12/24
Power(W/m)	12
CRI(Ra)	-
Lumen(Lm)	-
PCB Width(mm)	12
Cutting unit(mm)	25/50
Color	
IP Grade	



RGB COB Strip

LW-CRGB768-12W-24V-12F0

Picture



Dimension

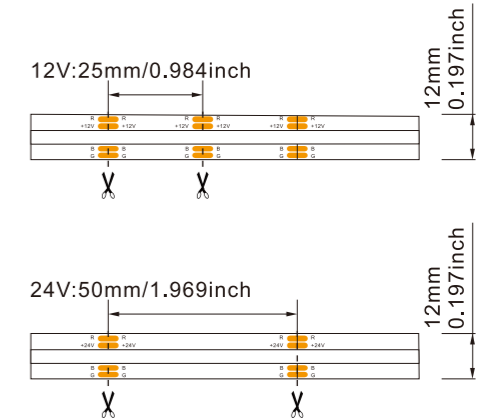

Qualification



Features

- High density COB strip light
- Soft and flexible PCB, easy to install
- Provide RGB colorful lights
- Wildly used as residential lighting and DIY lighting

Parameters

Model	LW-CRGB768-12W-24V-12F0
Led	SMD COB
Led Qty/m(pcs)	768
Voltage(DC V)	12/24
Power(W/m)	12
CRI(Ra)	-
Lumen(Lm)	-
PCB Width(mm)	12
Cutting unit(mm)	25/50
Color	
IP Grade	



RGB COB Strip

LW-COBRGB768-14W-12/24V-10F0-5M

Picture

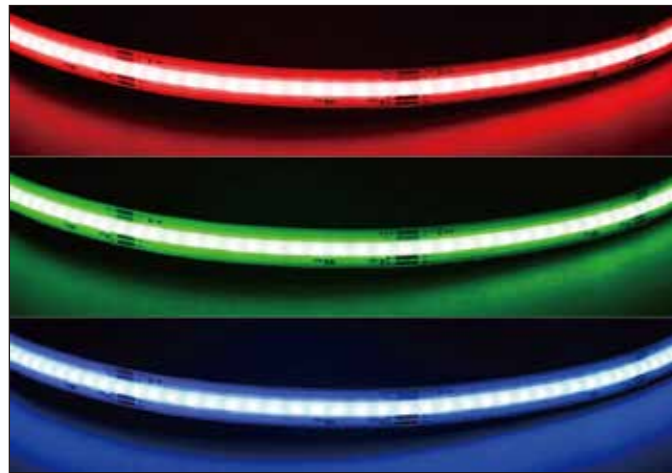

Dimension

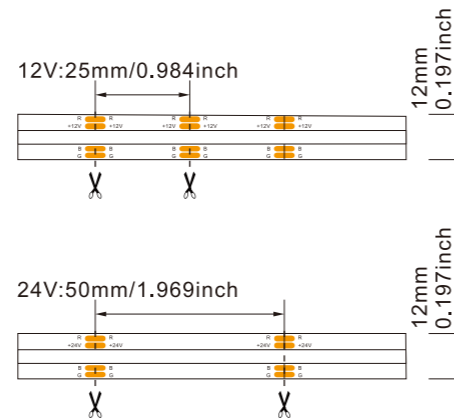

Qualification



Features

- High density COB strip light
- Soft and flexible PCB, easy to install
- Provide RGB colorful lights
- Wildly used as residential lighting and DIY lighting

Parameters

Model	LW-COBRGB768-14W-12/24V-10F0-5M
Led	SMD COB
Led Qty/m(pcs)	768
Voltage(DC V)	12/24
Power(W/m)	14
CRI(Ra)	-
Lumen(Lm)	-
PCB Width(mm)	10
Cutting unit(mm)	31.26
Color	R G B
IP Grade	IP20



RGB+W COB Strip

LW-CRGBW512-12W-24V-12F0

Picture



Dimension

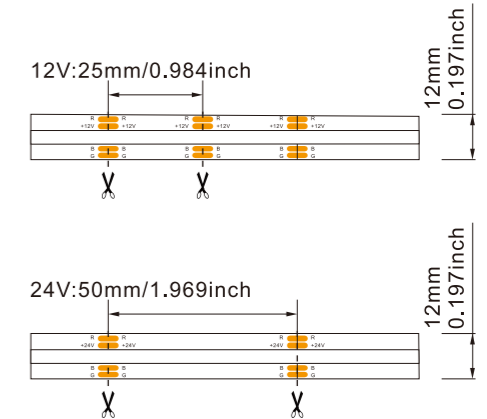

Qualification



Features

- High density COB strip light
- Soft and flexible PCB, easy to install
- Provide RGB colorful lights
- Wildly used as residential lighting and DIY lighting

Parameters

Model	LW-CRGBW512-12W-24V-12F0
Led	SMD COB
Led Qty/m(pcs)	512
Voltage(DC V)	12/24
Power(W/m)	12
CRI(Ra)	-
Lumen(Lm)	-
PCB Width(mm)	12
Cutting unit(mm)	25/50
Color	R G B W
IP Grade	IP20



CCT COB Strip

LW-CDW704-24W-24V-12F0 CCT

Picture



Dimension

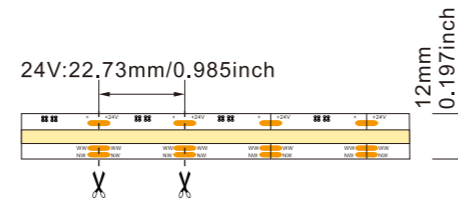

Qualification



Features

- High density COB strip up to 704LEDs/m.
- Soft and flexible PCB, easy to install
- Provide tunable color temperature from 3000K to 6500K
- High CRI, high brightness and light efficiency, low power consumption
- Wildly used as residential lighting and commercial lighting
- Dimmer recommended to adjust the color you need

Parameters

Model	LW-COBDW704-24W-24V-12F0-5M
Led	SMD COB
Led Qty/m(pcs)	704
Voltage(DC V)	24
Power(W/m)	12W/m for single CCT / 24W/m for mixed CCT
CRI(Ra)	>90
Lumen(Lm)	1080(WW) 2200(mixed CCT) 1140(CW)
PCB Width(mm)	12
Cutting unit(mm)	22.73
CCT	
IP Grade	IP20



Super slim COB Strip

LW-C27W384-10W-24V-06F0

Picture

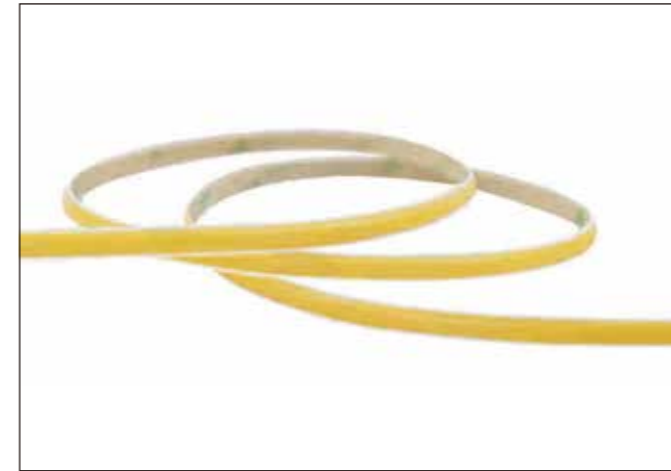

Dimension

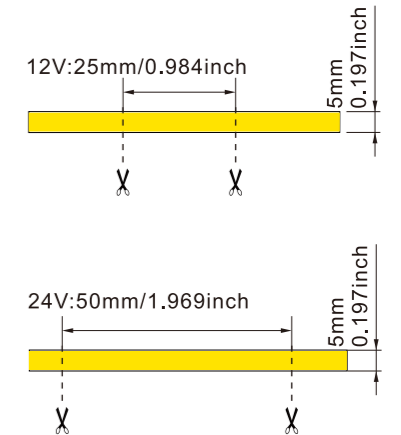

Qualification



Features

- Chips build on flexible PCB board
- High density COB LEDs
- Light dot free without any dark area, uniform light
- High CRI, high brightness and light efficiency, low power consumption

Parameters

Model	LW-C27W384-10W-24V-06F0
Led	SMD COB
Led Qty/m(pcs)	384
Voltage(DC V)	12/24
Power(W/m)	10
CRI(Ra)	>90
Lumen(Lm)	380
PCB Width(mm)	5
Cutting unit(mm)	50
CCT	
IP Grade	IP20



Super slim COB Strip

LW-COBX320-10W-12/24V-05F0-5M

Picture

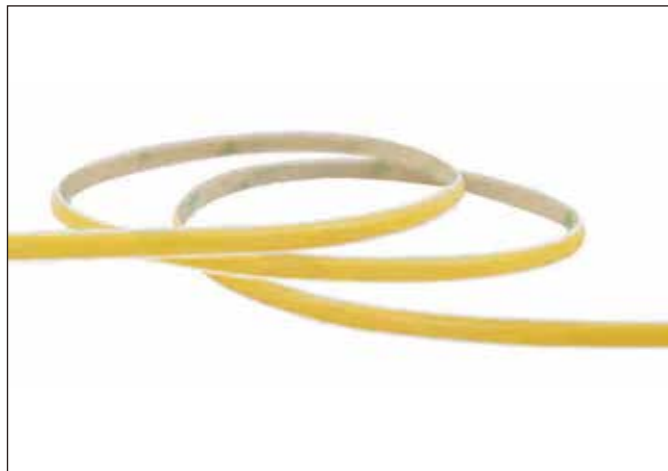

Dimension

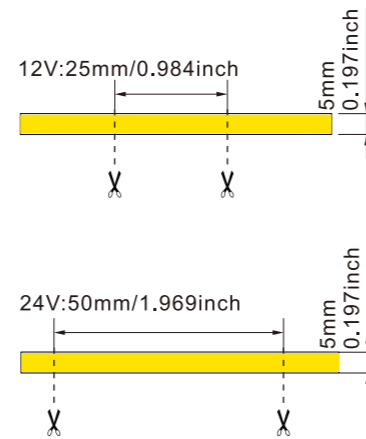

Qualification



Features

- Chips build on flexible PCB board
- High density COB LEDs
- Light dot free without any dark area, uniform light
- High CRI, high brightness and light efficiency, low power consumption

Parameters

Model	LW-COBX320-10W-12/24V-05F0-5M
Led	SMD COB
Led Qty/m(pcs)	320
Voltage(DC V)	12/24
Power(W/m)	10
CRI(Ra)	>90
Lumen(Lm)	850/900/1000/1100
PCB Width(mm)	5
Cutting unit(mm)	50
CCT	2700K 3000K 4000K 6500K R G B
IP Grade	IP20



Super slim COB Strip

LW-COBX512-10W-12/24V-05F0-5M

Picture

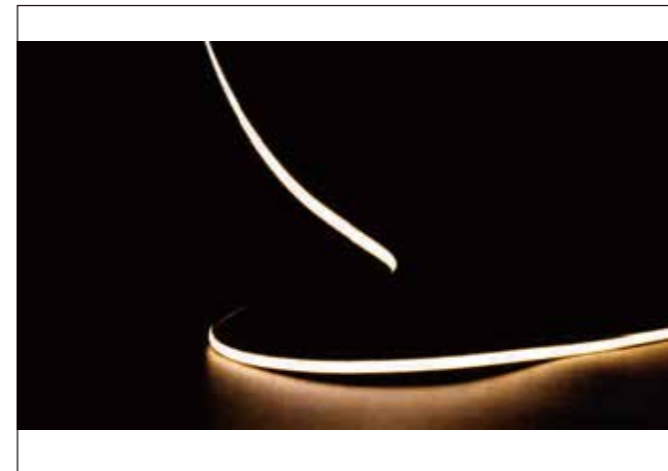

Dimension

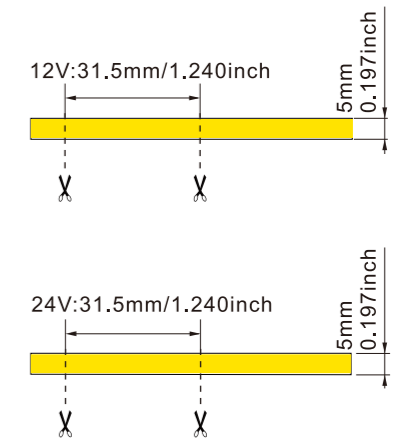

Qualification



Features

- High density COB strip
- Light dot free without any dark area, uniform light
- Super slim 5mm width PCB, weld points at the back of the strip
- Solder points at the back of the strip
- High CRI, high brightness and light efficiency, low power consumption

Parameters

Model	LW-COBX512-10W-12/24V-05F0-5M
Led	SMD COB
Led Qty/m(pcs)	512
Voltage(DC V)	12/24
Power(W/m)	12
CRI(Ra)	>90
Lumen(Lm)	960/1020/1200/1320
PCB Width(mm)	5
Cutting unit(mm)	31.5
CCT	2700K 3000K 4000K 6500K R G B
IP Grade	IP20

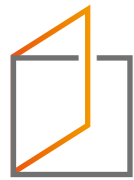

COB Strip Accessories

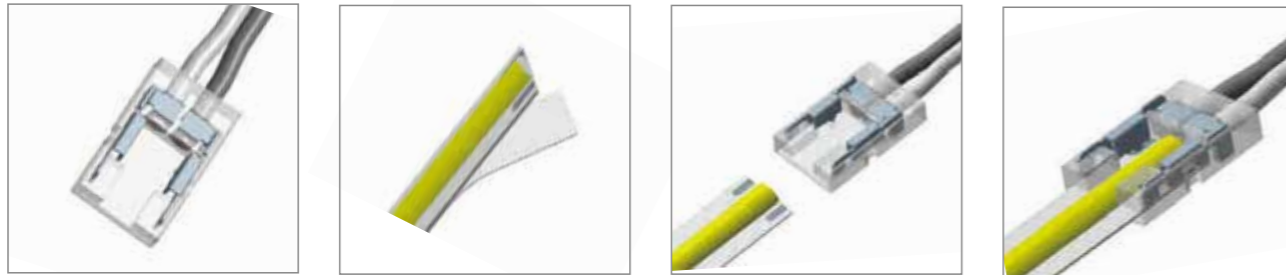

LW-A-SW-2
PCB width: 8/10mm
Color: Single color



LW-A-SS-2
PCB width: 8/10mm
Color: Single color



LW-A-SCS-2
PCB width: 8/10mm
Color: Single color



60LED 2835 strip

LW-L2835X60-3.6W-12/24-8F0

Picture



Dimension

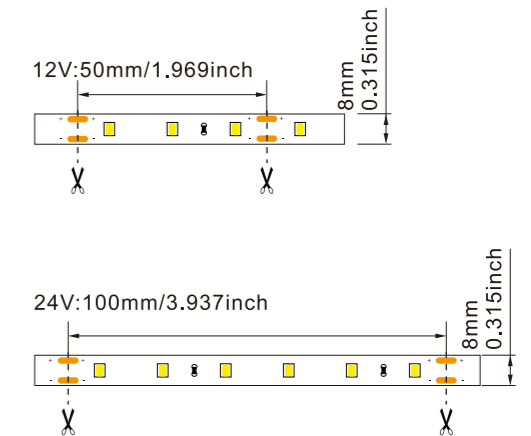

Qualification



Features

- Flexible ribbon for curving around bends
- Easy installation
- Ultra-bright but running at low temperature with low power consumption
- LM-80 L ED CRI80 CRI90 even CRI95
- Wildly used for architecture, commercial, residential decoration and lighting

Parameters

Model	LW-L2835X60-3.6W-12/24-8F0
Led	SMD 2835
Led Qty/m(pcs)	60
Voltage(DC V)	12/24
Power(W/m)	3.6
CRI(Ra)	>80
Lumen(Lm)	320/350/360
PCB Width(mm)	8
Cutting unit(mm)	50/100
CCT	2700K 3000K 4000K 6500K R G B
IP Grade	IP20 IP64 IP65 IP68



120LED 2835 strip

LW-L2835X120-8.5W-12/24-8F0

Picture



Dimension

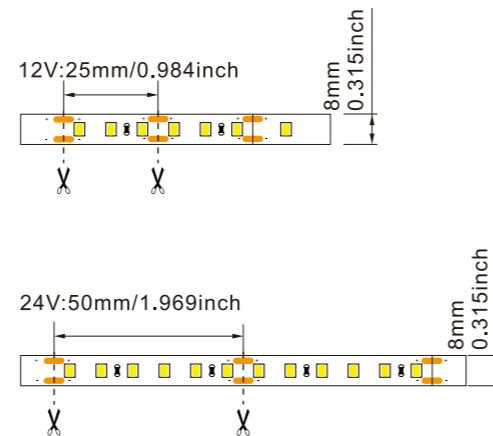

Qualification



Features

- Flexible ribbon for curving around bends
- Easy installation
- Ultra-bright but running at low temperature with low power consumption
- LM-80 L ED CRI80 CRI90 even CRI95
- Wildly used for architecture, commercial, residential decoration and lighting

Parameters

Model	LW-L2835X120-8.5W-12/24-8F0
Led	SMD 2835
Led Qty/m(pcs)	120
Voltage(DC V)	12/24
Power(W/m)	8.5
CRI(Ra)	>80
Lumen(Lm)	780/800/850
PCB Width(mm)	8
Cutting unit(mm)	25/50
CCT	2700K 3000K 4000K 6500K
IP Grade	



240LED 2835 strip

LW -L2835X240-18W-12/24V-10F0

Picture



Dimension

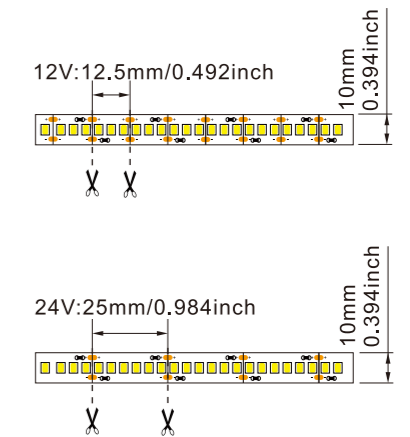

Qualification



Features

- Flexible ribbon for curving around bends
- Easy installation
- Ultra-bright but running at low temperature with low power consumption
- LM-80 L ED CRI80 CRI90 even CRI95
- Wildly used for architecture, commercial, residential decoration and lighting

Parameters

Model	LW -L2835X240-18W-12/24V-10F0
Led	SMD 2835
Led Qty/m(pcs)	240
Voltage(DC V)	12/24
Power(W/m)	18
CRI(Ra)	>80
Lumen(Lm)	1530/1620/1800
PCB Width(mm)	10
Cutting unit(mm)	12.5/25
CCT	2700K 3000K 4000K 6500K
IP Grade	



3-Step series SMD 2835

LW -G2835X180-14.4W-12/24V-10F0

Picture



Dimension

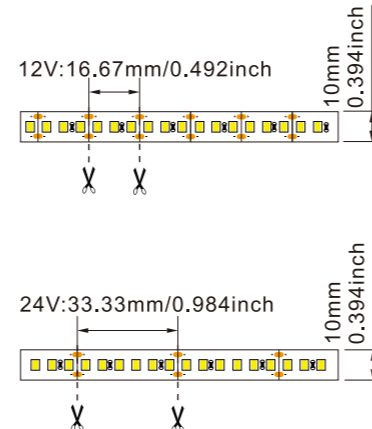

Qualification



Features

- Flexible ribbon for curving around bends
- Easy installation
- High brightness with low power consumption
- 3-step Mcadam provides high light uniformity
- LM-80 L ED CRI80 CRI90 even CRI95
- Wildly used for architecture, commercial, residential decoration and lighting

Parameters

Model	LW -G2835X180-14.4W-12/24V-10F0
Led	SMD 2835
Led Qty/m(pcs)	180
Voltage(DC V)	12/24
Power(W/m)	14.4
CRI(Ra)	>80
Lumen(Lm)	1200/1260/1440
PCB Width(mm)	10
Cutting unit(mm)	16.67/33.33
CCT	2700K 3000K 4000K 6500K
IP Grade	



High Efficiency series SMD 2835

LW -GH2835X64-9.6W-12/24V-8F0

Picture



Dimension

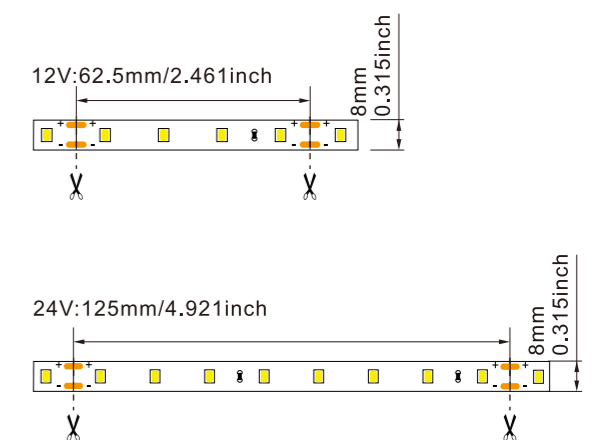

Qualification



Features

- Flexible ribbon for curving around bends
- Easy installation
- Super brightness with high light efficiency (up to 170lm/W) and low power consumption
- LM-80 L ED CRI80 CRI90 even CRI95
- Wildly used for architecture, commercial, residential decoration and lighting

Parameters

Model	LW -GH2835X64-9.6W-12/24V-8F0
Led	SMD 2835
Led Qty/m(pcs)	64
Voltage(DC V)	12/24
Power(W/m)	9.6
CRI(Ra)	>80
Lumen(Lm)	1490/1590/1630
PCB Width(mm)	8
Cutting unit(mm)	62.5/125
CCT	2700K 3000K 4000K 6500K
IP Grade	



60LED 5050 Single Color

LW -L5050X60-14.4W-12/24V-10F0

Picture



Dimension

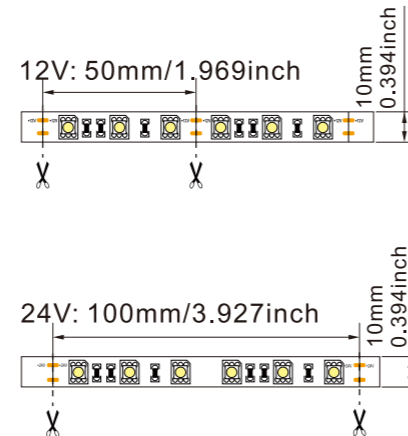

Qualification



Features

- Soft and flexible LED strip
- Easy installation
- High brightness with low power consumption
- Wildly used for architecture, commercial, residential decoration and lighting

Parameters

Model	LW -L5050X60-14.4W-12/24V-10F0
Led	SMD 5050
Led Qty/m(pcs)	60
Voltage(DC V)	12/24
Power(W/m)	14.4
CRI(Ra)	>80
Lumen(Lm)	1200
PCB Width(mm)	10
Cutting unit(mm)	50/100
CCT	2700K 3000K 4000K 6500K R G B
IP Grade	IP20 IP64 IP65 IP68



30LED 5050 RGB

LW -L5050RGB30-7.2W-12/24V-10F0

Picture



Dimension

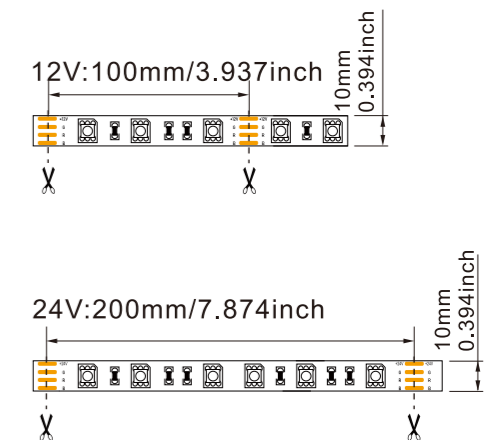

Qualification



Features

- Soft and flexible LED strip
- Easy installation
- High brightness with low power consumption
- Provides RGB colorful light
- Wildly used for DIY, landscape lighting

Parameters

Model	LW -L5050RGB30-7.2W-12/24V-10F0
Led	SMD5050
Led Qty/m(pcs)	30
Voltage(DC V)	12/24
Power(W/m)	7.2
CRI(Ra)	-
Lumen(Lm)	-
PCB Width(mm)	10
Cutting unit(mm)	100/200
Color	R G B
IP Grade	IP20 IP64 IP65 IP68



60LED 5050 RGB

LW -L5050RGB60-14.4W-12/24V-10F0

Picture



Dimension

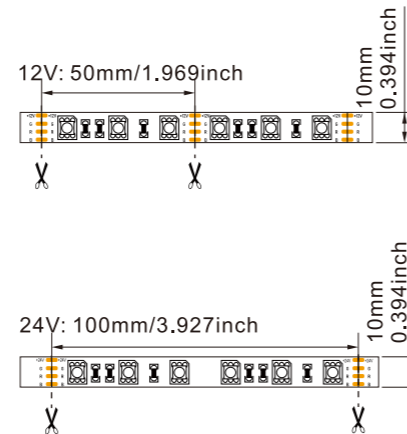

Qualification



Features

- Soft and flexible LED strip
- Easy installation
- High brightness with low power consumption
- Provides RGB colorful light
- Wildly used for DIY, landscape lighting

Parameters

Model	LW -L5050RGB60-14.4W-12/24V-10F0
Led	SMD 5050
Led Qty/m(pcs)	60
Voltage(DC V)	12/24
Power(W/m)	14.4
CRI(Ra)	-
Lumen(Lm)	-
PCB Width(mm)	10
Cutting unit(mm)	50/100
Color	R G B
IP Grade	IP20 IP64 IP65 IP68



Magic Color Series

LW -L5050RGBIC30-4.8W-12/24V-10F0

Picture



Dimension

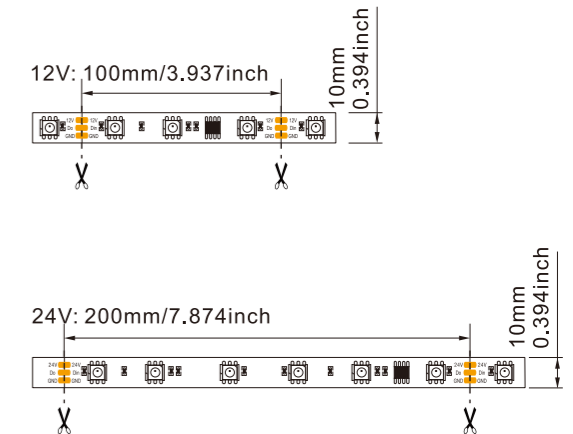

Qualification



Features

- Addressable full color led strips
- Individually control -1 IC/cut.
- Easy installation
- Support variety, shaped image(such as chasing light, water effects, full-color dynamic mix changes, etc)
- Wildly used as a large building in the dot matrix display screen use, easy to install, no similar large display the same cooling system, relatively low costs of inputs.

Parameters

Model	LW -L5050RGBIC30-4.8W-12/24V-10F0
Led	SMD 5050
Led Qty/m(pcs)	30
Voltage(DC V)	12/24
Power(W/m)	4.8
CRI(Ra)	-
Lumen(Lm)	-
PCB Width(mm)	10
Cutting unit(mm)	100/200
Color	R G B
IP Grade	IP20 IP64 IP65



Magic Color Series

LW -L5050RGBIC60-7.2W-12/24V-10F0

Picture

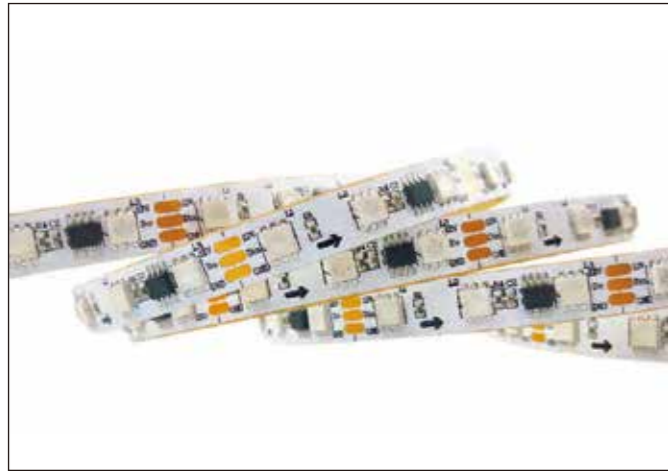

Dimension

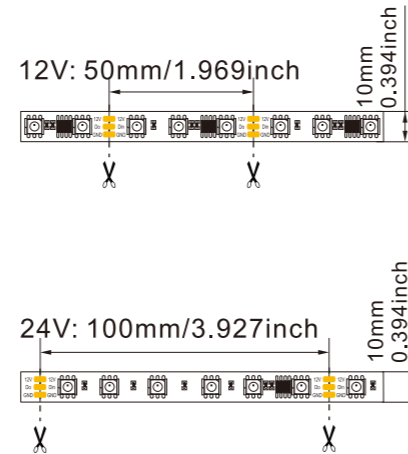

Qualification



Features

- Addressable full color led strips
- Individually control -1 IC/cut.
- Easy installation
- Support variety, shaped image(such as chasing light, water effects, full-color dynamic mix changes, etc)
- Wildly used as a large building in the dot matrix display screen use, easy to install, no similar large display the same cooling system, relatively low costs of inputs.

Parameters

Model	LW -L5050RGBIC60-7.2W-12/24V-10F0
Led	SMD 5050
Led Qty/m(pcs)	60
Voltage(DC V)	12/24
Power(W/m)	7.2
CRI(Ra)	-
Lumen(Lm)	-
PCB Width(mm)	10
Cutting unit(mm)	50/100
Color	R G B
IP Grade	IP20 IP64 IP65 IP68



60LED RGBW Mixed Light

LW -G5050RGBW60-9.6W-12/24V-10F0

Picture



Dimension

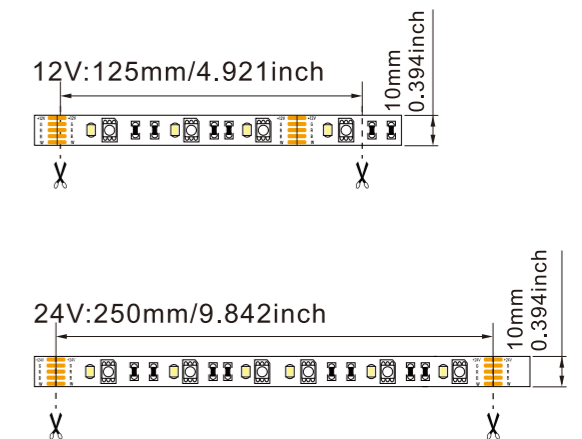

Qualification



Features

- Soft and flexible LED strip
- Easy installation
- High brightness with low power consumption
- SMD 5050 LED provide RGB color lights and SMD 2835 LED provide white light
- Wildly used for architecture, commercial, residential lighting

Parameters

Model	LW -G5050RGBW60-9.6W-12/24V-10F0
Led	SMD2835 + SMD5050
Led Qty/m(pcs)	60
Voltage(DC V)	12/24
Power(W/m)	12
CRI(Ra)	>80(only for white light)
Lumen(Lm)	370
PCB Width(mm)	10
Cutting unit(mm)	125/250
Color	R G B W
IP Grade	IP20 IP64 IP65 IP68



90LED RGB+Tunable White Mixed Light

LW -G5050RGBDW90-10W-12/24V-12F0

Picture



Dimension

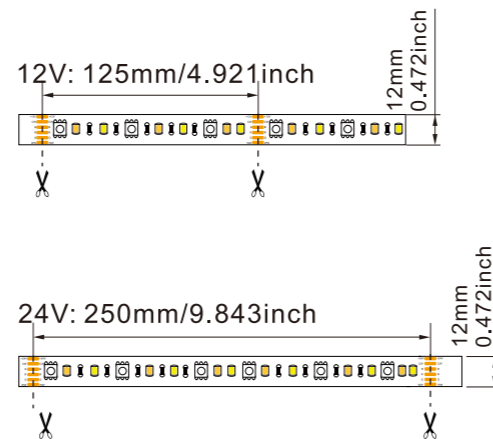

Qualification



Features

- Soft and flexible LED strip
- Easy installation
- High brightness with low power consumption
- SMD 5050 LED provide RGB color lights and SMD 2835 LED provide warm and cool white light
- Dimmable and CCT adjustable
- Wildly used for architecture, commercial, residential lighting

Parameters

Model	LW -G5050RGBDW90-10W-12/24V-12F0
Led	SMD 2835
Led Qty/m(pcs)	90
Voltage(DC V)	12/24
Power(W/m)	10
CRI(Ra)	>80(only for white light)
Lumen(Lm)	-
PCB Width(mm)	12
Cutting unit(mm)	125/250
CCT	2700K 6000K
IP Grade	IP20 IP64 IP65 IP68



Side view 6*12

Picture

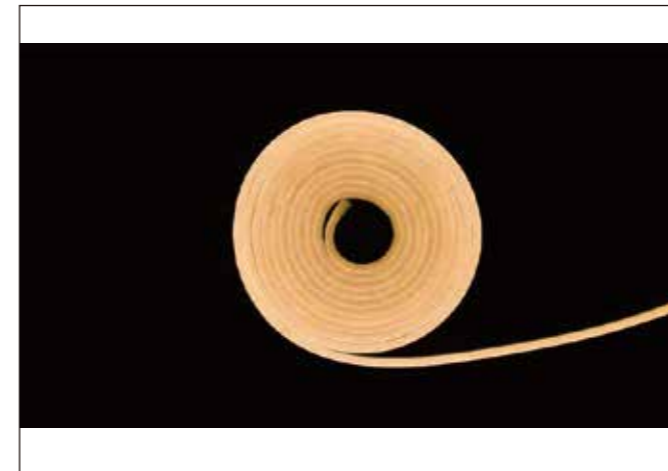

Dimension

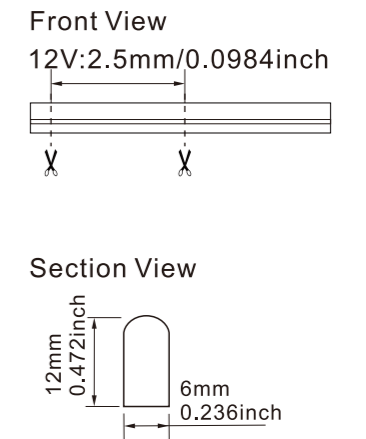

Qualification



Features

- Soft and flexible LED neon strip, easy to make various shapes
- Easy installation
- Dome surface, continuous and uniform illumination, no LED dot or dark spot.
- Durability, impact resistant, weather resistant, minimal heat output (Safe to the touch)

Parameters

Model	Side view 6*12
Led	SMD 2835
Led Qty/m(pcs)	120
Voltage(DC V)	12/24
Power(W/m)	9.6
CRI(Ra)	-
Lumen(Lm)	-
PCB Width(mm)	6
Cutting unit(mm)	2.5
CCT	Red, Purple, Pink, Blue, Ice Blue, Green, Lemon Yellow, Golden, Warm White, White
IP Grade	IP67



Non-wire strip

www.ledwaylighting.com | jelly@ledwaylighting.com



- No wire design, joint directly with guide electricity, more secure, use longer
- Optimizing the LED chip, optical, uniform lighting, light and comfortable, anti aging, anti glare
- Double parallel design, the parallel connection, a does not affect the other lamp bead light bead is not on normal operation
- Mark splicing and careful is negative sign, cutting across the electrodes with operations in the clear
- Configuration USES high-grade materials, environmental protection PVC flame retardant rubber, waterproof good perviousto light, have qualitative feeling soft and smooth

Model	LW-H2835X100 -W1-9W-220V	LW-HW5730X100 -W1-9W-220V	LW-H2835X60 -W10-6W-220V	LW-H2835X120 -W10-9W-220V	LW-HW2835X180 -W10-10W-220V
Led	SMD2835	SMD2835	SMD2835	SMD2835	SMD2835
Led Qty/m	100LEDs	100LEDs	100LEDs	100LEDs	100LEDs
Voltage	AC220V	AC220V	AC220V	AC220V	AC220V
Power(W/m)	9-10W	9-10W	9-10W	9-10W	9-10W
CCT	3000K/4000K/6000K	3000K/4000K/6000K	3000K/4000K/6000K	3000K/4000K/6000K	3000K/4000K/6000K
CRI(Ra)	>80	>80	>80	>80	>80
Lumen per LED	24-26lm	24-26lm	24-26lm	24-26lm	24-26lm
PCB Width	10mm	10mm	10mm	10mm	10mm
IP Rate	IP65	IP65	IP65	IP65	IP65
Cutting unit	100mm(10LED)	100mm(10LED)	100mm(10LED)	100mm(10LED)	100mm(10LED)
Product Size	14*6mm	14*6mm	14*6mm	14*6mm	14*6mm

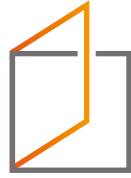

220V Wire Quotation

www.ledwaylighting.com | jelly@ledwaylighting.com

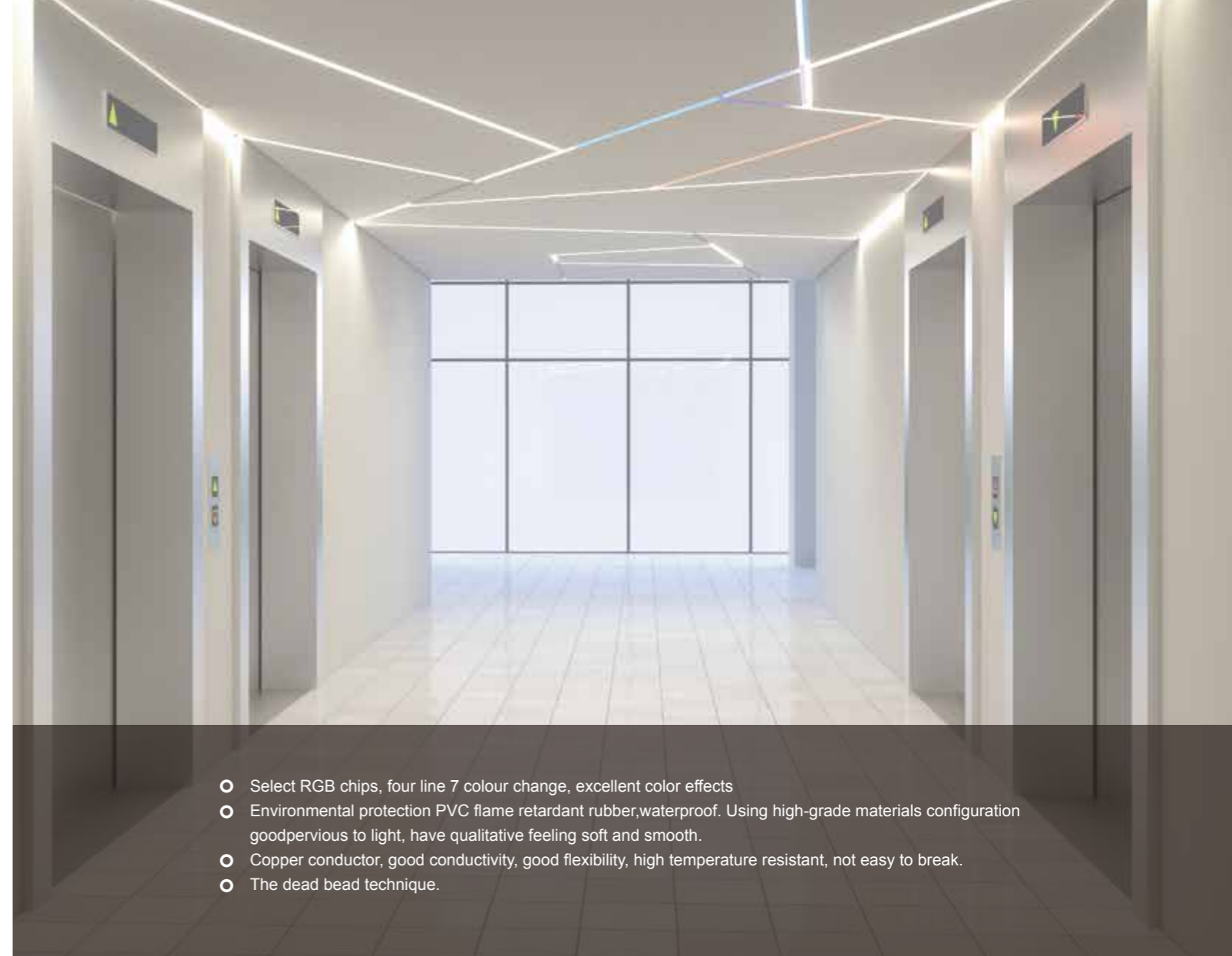

- Select RGB chips, four line 7 colour change, excellent color effects
- Environmental protection PVC flame retardant rubber, waterproof. Using high-grade materials configuration good pervious to light, have qualitative feeling soft and smooth.
- Copper conductor, good conductivity, good flexibility, high temperature resistant, not easy to break.
- The dead bead technique.

Model	LW-H2835X116-4W-220V	LW-H2835X120-4W-220V	LW-H5050X60-6W-220V
Led	SMD2835	SMD2835	SMD5050
Led Qty/m	116LEDs	120LEDs	60LEDs
Voltage	AC220V	AC220V	AC220V
Power(W/m)	4-5W	4-5W	5-7W
CCT	WW/CWW	3000K/6000K	3000K/4000K/6000K
CRI(Ra)	>60	>60	>80
Lumen per led	10-12lm	10-12lm	18-20lm
PCB Width	9mm	10mm	10mm
IP Rate	IP65	IP65	IP65
Cutting unit	1M	1M	1M
Product Size	12.7*6mm	12.7*6mm	16*7mm



220V Wire Quotation

www.ledwaylighting.com | jelly@ledwaylighting.com

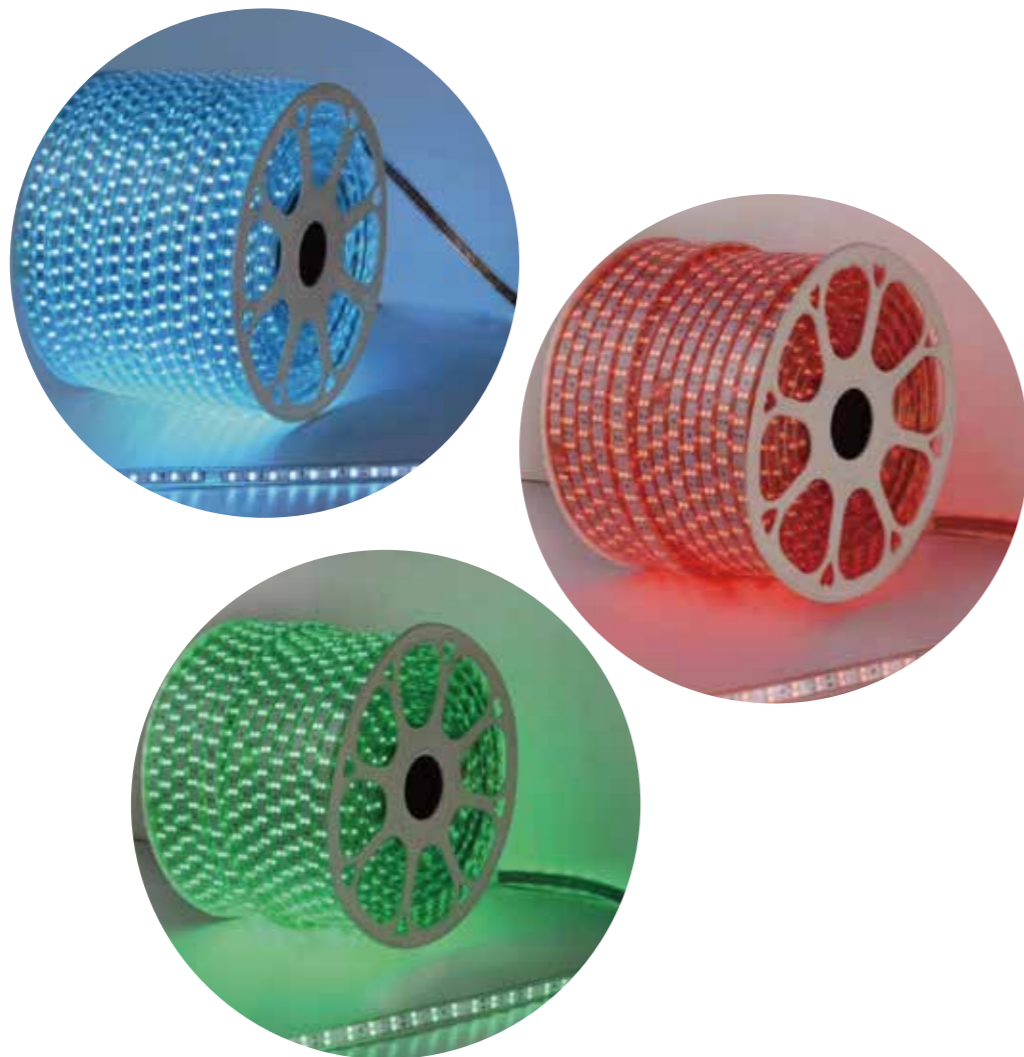

LW-H5050RGB60-8W-220V



- Select RGB chips, four line 7 colour change, excellent color effects.
- Environmental protection PVC flame retardant rubber, waterproof. Using high-grade materials configuration, goodpervious to light, have qualitative feeling soft and smooth.
- Copper conductor, good conductivity, good flexibility, high temperature resistant, not easy to break.The dead bead technique.

Model	LW-H5050RGB60-8W-220V
Led	SMD5050RGB
Led Qty/m	60LEDs
Voltage	AC220V
Power(W/m)	5-7W
Color	RGB
PCB Width	12mm
IP Rate	IP65
Cutting unit	1M
Product Size	16*7.5mm



Neon Flex

www.ledwaylighting.com | jelly@ledwaylighting.com



LW-HN180-8W-220V



LW-HN360-8W-220V



- Using prevent sulfide highlight LED light source.
- Appearance looks like a conventional glass neon tube
- Long life, low energy consumption, the color is complete, high brightness
- Flexible control, the lamp body soft, easy to shape
- Energy saving province electricity, high performance-price ratio

○ Packaging options

- Blister packaging
- Color box

Model	LW-HN180-8W-220V	LW-HN360-8W-220V
Led		
Voltage	AC220V	AC220V
Power(W/m)	7-9W	7-9W
CCT	WW/WB/R/G/Y/AM/P	WW/WB/R/G/Y/AM/P
Lumen per led	24-26lm	24-26lm
PCB Width	6mm	6mm
IP Rate	IP65	IP65
Cutting unit	1m	1m
Product Size	9*16mm	15*16mm



Single color full kit

LW -5050-30-single colour-12V

Picture



Dimension

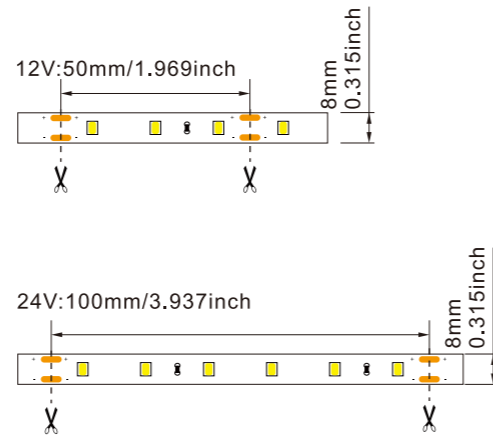

Qualification



Features

- Soft and flexible LED strip
- Easy installation
- DC plug connect on the strip directly
- Wildly used as linear light in residential lighting and commercial lighting, such as accent lighting, contour lighting, stair, doorstep lighting, cabinet lighting.

Parameters

Model	LW -5050-30-single colour	LW -2835-60-single colour	LW -5050-60-single colour	LW -2835-120-single colour
Led	SMD 5050	SMD 2835	SMD 5050	SMD 2835
Led Qty/m(pcs)	30	60	60	120
Voltage(DC V)	12/24	12/24	12/24	12/24
Power(W/m)	7.2	4.8	14.4	9.6
CRI(Ra)	>90	>90	>90	>90
Lumen(Lm)	400/420/480	400/420/480	400/420/480	400/420/480
PCB Width(mm)	8	8	8	8
Cutting unit(mm)	50/100	50/100	50/100	50/100
CCT				
IP Grade				



RGB IR/RF full kit

LW -P5050RGB30-4W-12/24V-10F0-5M

Picture



Dimension

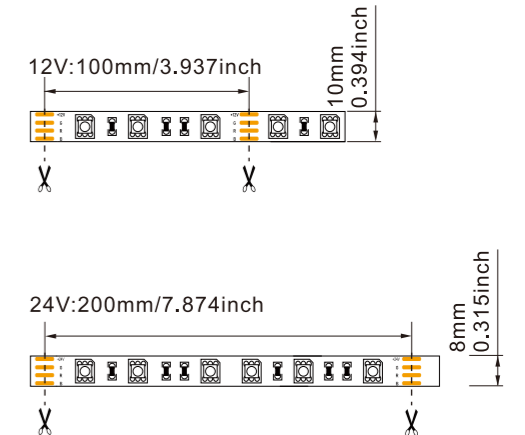

Qualification



Features

- Soft and flexible LED strip
- Easy installation
- Control the strip lighting with remoter, 1 6 static colors and 4 lighting modes
- Wildly used as DIY lighting and landscape lighting

Parameters

Model	LW -P5050RGB30-4W-12/24V-10F0-5M	LW -P5050RGB60-7.2W-12/24V-10F0-5M
Led	SMD 5050	SMD 5050
Led Qty/m(pcs)	30	60
Voltage(DC V)	12/24	12/24
Power(W/m)	4	7.2
CRI(Ra)	-	-
Lumen(Lm)	-	-
PCB Width(mm)	10	10
Cutting unit(mm)	100/200	50/100
CCT		
IP Grade		



CCT full kit

LW -2835-60-CCT-12V

Picture



Dimension

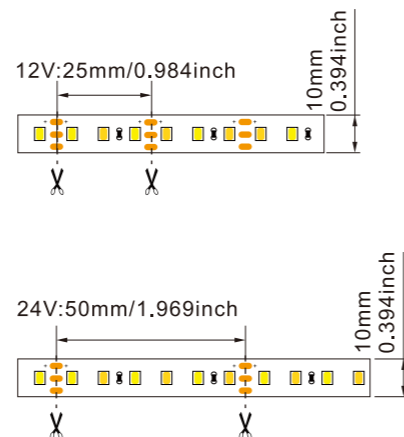

Qualification



Features

- Soft and flexible LED strip
- Easy installation
- Provide warm white or cool white light with CCT from 3000K to 6500K
- Wildly used as linear light in residential lighting and commercial lighting, such as accent lighting, contour lighting, stair, doorstep lighting, cabinet lighting.

Parameters

Model	LW -2835-60-CCT-12V	LW -2835-120-CCT-12V
Led	SMD 2835	SMD 2835
Led Qty/m(pcs)	60	120
Voltage(DC V)	12/24	12/24
Power(W/m)	4.8W/m	9.6W/m
CRI(Ra)	>90	>90
Lumen(Lm)	810/1770/960	810/1770/960
PCB Width(mm)	10	10
Cutting unit(mm)	25/50	25/50
CCT		
IP Grade		



RGB+Single color IR full kit

LW -P5050RGBW48-4.8W-12/24V-10F0-5M

Picture



Dimension

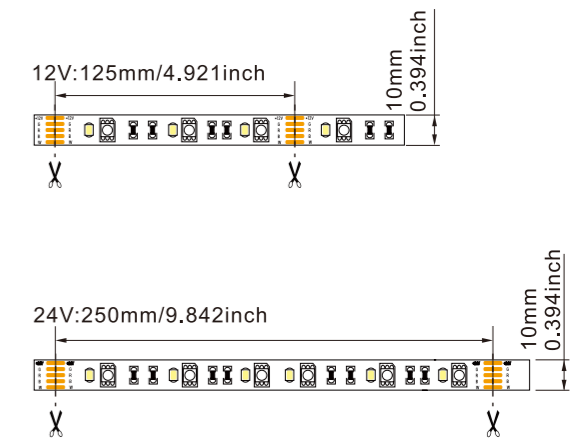

Qualification



Features

- Soft and flexible L ED strip
- Easy installation
- SMD 5050 LEDs provide RGB colors and SMD 2835 provide white light.
- Control the strip lighting with remoter, 20 static colors, 8 lighting modes.
- Wildly used as DIY lighting and landscape lighting

Parameters

Model	LW -P5050RGBW48-4.8W-12/24V-10F0-5M	LW -P5050RGBW60-6W-12/24V-10F0-5M
Led	SMD2835 + SMD5050	SMD2835 + SMD5050
Led Qty/m(pcs)	48	60
Voltage(DC V)	12/24	12/24
Power(W/m)	4.8	6
CRI(Ra)	-	-
Lumen(Lm)	-	-
PCB Width(mm)	10	10
Cutting unit(mm)	125/250	100/200
CCT		
IP Grade		



90LED RGB+Tunable white IR/RF full kit

LW -P5050RGBDW90-9.6W-12/24V-10F0-5M

Picture



Dimension

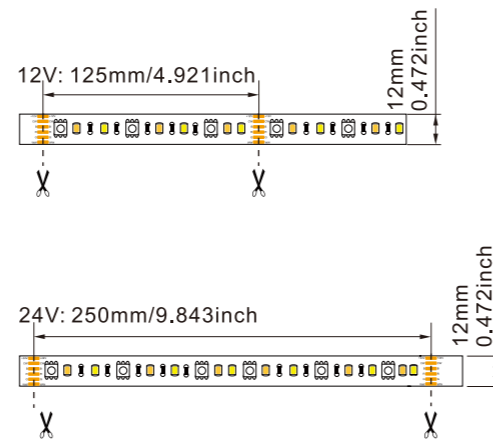

Qualification



Features

- Soft and flexible LED strip
- Easy installation
- SMD 5050 LEDs provide RGB colors and SMD 2835 LEDs provide warm white and cool white lights.
- Control the strip lighting with remoter, 20 static colors, 8 lighting modes.
- Wildly used as DIY lighting and landscape lighting

Parameters

Model	LW -P5050RGBDW90-9.6W-12/24V-10F0-5M
Led	SMD5050 + SMD2835
Led Qty/m(pcs)	90
Voltage(DC V)	12/24
Power(W/m)	7.2
CRI(Ra)	-
Lumen(Lm)	-
PCB Width(mm)	12
Cutting unit(mm)	125/250
CCT	R G B + Tunable White
IP Grade	IP20 IP64 IP65 IP68



30LED TV USB RGB IR/RF full kit

LW -P5050RGB30-3W-5V-10F0-2M

Picture



Dimension

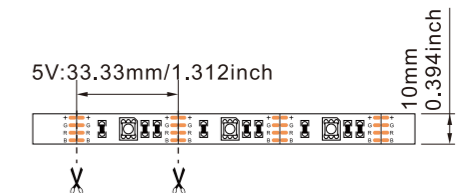

Qualification



Features

- Soft and flexible LED strip
- Solid USB interface, powered by the USB port of TV set, plug and play.
- Easy installation
- Control the strip lighting with remoter, 7 static colors and multi lighting modes
- One chip each cutting.

Parameters

Model	LW -P5050RGB30-3W-5V-10F0-2M
Led	SMD 5050
Led Qty/m(pcs)	30
Voltage(DC V)	5
Power(W/m)	3
CRI(Ra)	-
Lumen(Lm)	-
PCB Width(mm)	10
Cutting unit(mm)	33.3
CCT	R G B
IP Grade	IP20 IP64



30LED RGB music strip full kit

LW -5050-30-RGB--12V

Picture



Dimension

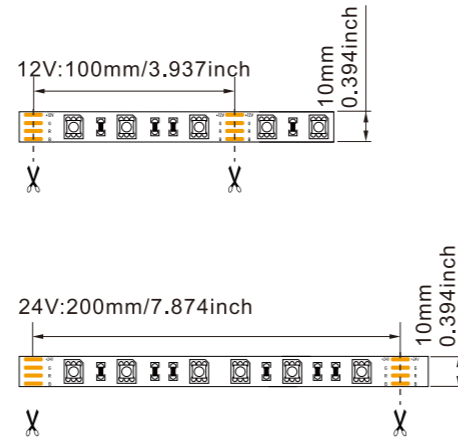

Qualification



Features

- Soft and flexible LED strip
- Easy installation
- Simply control the strip lighting with remoter with 20 static colors, 8 lighting modes and 4 music modes.
- Control the strip lighting with mobile phone APP with multi functions: 16 million colors, music and mic function, lights color changes with the music beats or your mobile phone.

Parameters

Model	LW -5050-30-RGB--12V
Led	SMD 5050
Led Qty/m(pcs)	30
Voltage(DC V)	12/24
Power(W/m)	7.2
CRI(Ra)	-
Lumen(Lm)	-
PCB Width(mm)	10
Cutting unit(mm)	100/200
CCT	
IP Grade	



30LED RGB Bluetooth music strip full kit

LW -5050-30-RGB-12V-Bluetooth Music strip

Picture



Dimension

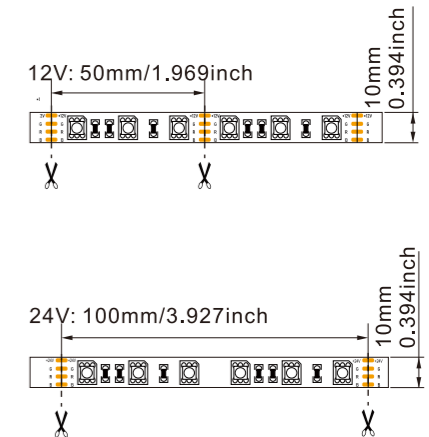

Qualification



Features

- Soft and flexible LED strip
- Easy installation
- Simply control the strip lighting with remoter with 13 static colors, 4 lighting modes and 3 music modes.
- Control the strip lighting with mobile phone APP with multi functions:16 million colors, music and mic function, lights color changes with the music beats or your mobile phone.

Parameters

Model	LW -5050-30-RGB-12V-Bluetooth Music strip
Led	SMD 5050
Led Qty/m(pcs)	30
Voltage(DC V)	12/24
Power(W/m)	7.2
CRI(Ra)	-
Lumen(Lm)	-
PCB Width(mm)	10
Cutting unit(mm)	50/100
CCT	
IP Grade	



RGB Bluetooth full kit

LW -PB5050RGB30-4W-12/24V-10F0-5M

Picture



Dimension

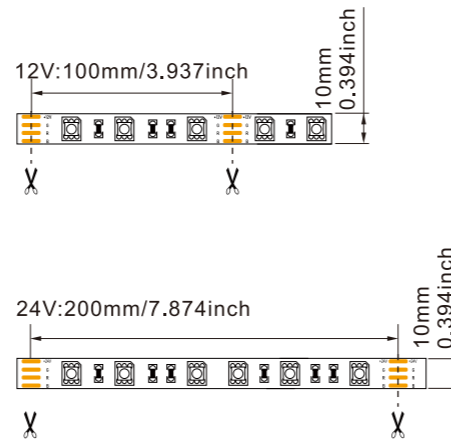

Qualification



Features

- Soft and flexible LED strip
- Easy installation
- Simply control the strip lighting with remoter with 20 static colors, 8 lighting modes and 4 music modes.
- Control the strip lighting with mobile phone APP with multi functions: 16 million colors, music and mic function, lights color changes with the music beats or your mobile phone.

Parameters

Model	LW -PB5050RGB30-4W-12/24V-10F0-5M	LW -PB5050RGB60-7.2W-12/24V-10F0-5M
Led	SMD 5050	SMD 5050
Led Qty/m(pcs)	30	60
Voltage(DC V)	12/24	12/24
Power(W/m)	4	7.2
CRI(Ra)	-	-
Lumen(Lm)	-	-
PCB Width(mm)	10	10
Cutting unit(mm)	100/200	50/100
CCT		
IP Grade		



48LED RGB+Single color Bluetooth type

LW -PB5050RGBW48-4.8W-12/24V-10F0-5M

Picture



Dimension

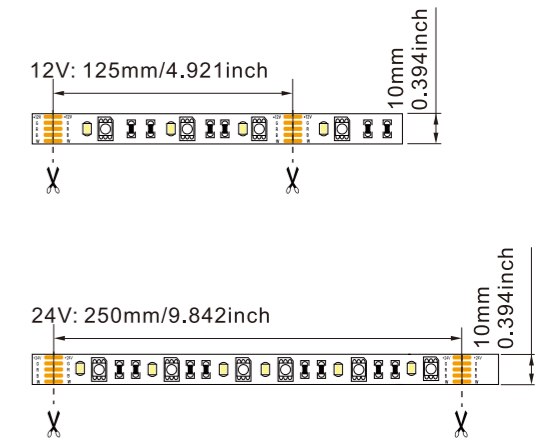

Qualification



Features

- Soft and flexible LED strip
- Easy installation
- Control the strip lighting with mobile phone APP with multi functions: 16 million colors, music and mic function, lights color changes with the music beats or your mobile phone.

Parameters

Model	LW -PB5050RGBW48-4.8W-12/24V-10F0-5M
Led	SMD2835 + SMD5050
Led Qty/m(pcs)	48
Voltage(DC V)	12/24
Power(W/m)	4.8
CRI(Ra)	-
Lumen(Lm)	-
PCB Width(mm)	10
Cutting unit(mm)	125/250
CCT	
IP Grade	



60LED RGB+Single color Bluetooth type

LW -PB5050RGBW60-6W-12/24V-10F0-5M



30LED RGB WIFI type

LW -PW5050RGB30-4W-12/24V-10F0-5M

Picture



Dimension

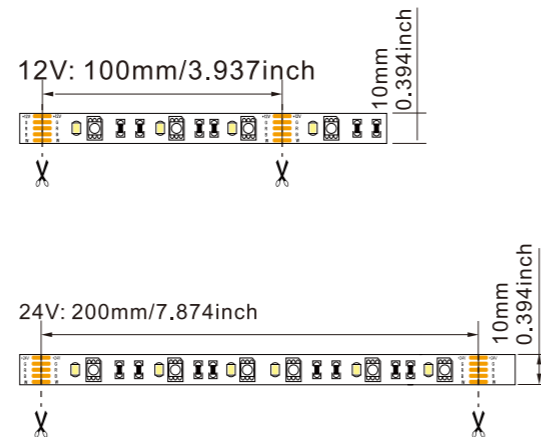

Picture



Dimension

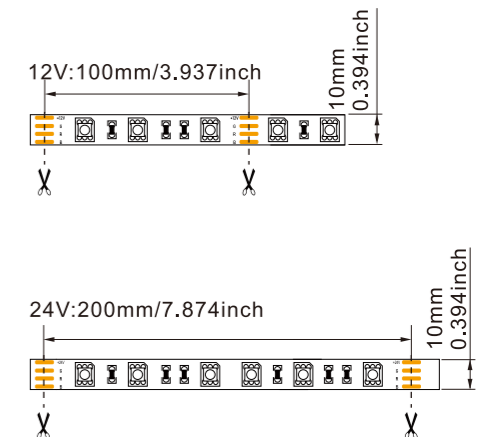

Qualification



Features

- Soft and flexible LED strip
- Easy installation
- Control the strip lighting with mobile phone APP with multi functions: 16 million colors, music and mic function, lights color changes with the music beats or your mobile phone.

Qualification



Features

- Soft and flexible LED strip
- Easy installation
- Simply control the strip lighting with remoter with 13 static colors, 4 lighting modes and 3 music modes.
- Control the strip lighting with TUYAAPP with multi functions: 16 million colors, music and mic function, lights color changes with the music beats or your mobile phone.

Parameters

Model	LW -PB5050RGBW60-6W-12/24V-10F0-5M
Led	SMD2835 + SMD5050
Led Qty/m(pcs)	60
Voltage(DC V)	12/24
Power(W/m)	6
CRI(Ra)	-
Lumen(Lm)	-
PCB Width(mm)	10
Cutting unit(mm)	100/200
CCT	R G B W
IP Grade	IP20 IP64 IP65 IP68

Parameters

Model	LW -PW5050RGB30-4W-12/24V-10F0-5M	LW -PW5050RGB60-7.2W-12/24V-10F0-5M
Led	SMD 5050	SMD 5050
Led Qty/m(pcs)	30	60
Voltage(DC V)	12/24	12/24
Power(W/m)	4	7.2
CRI(Ra)	-	-
Lumen(Lm)	-	-
PCB Width(mm)	10	10
Cutting unit(mm)	100/200	50/100
CCT	R G B	
IP Grade	IP20 IP64 IP65 IP68	



RGB+Single color WIFI type

LW -PW5050RGBW48-4.8W-12/24V-10F0-5M

Picture



Dimension

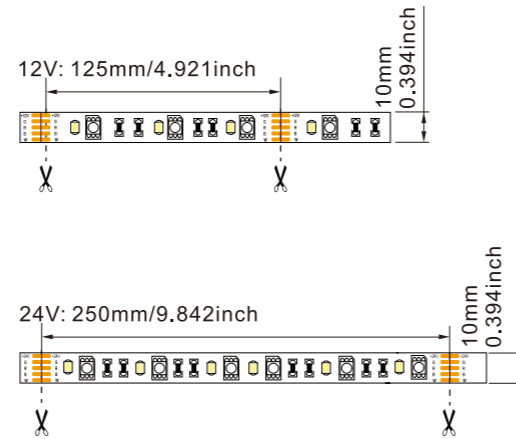

Qualification



Features

- Soft and flexible LED strip .
- Easy installation
- Control the strip lighting with TUYAAPP with multi functions:1 6 million colors, music and mic function, lights color changes with the music beats or your mobile phone.

Parameters

Model	LW -PW5050RGBW48-4.8W-12/24V-10F0-5M	LW -PW5050RGBW60-6W-12/24V-10F0-5M
Led	SMD2835 + SMD5050	SMD2835 + SMD5050
Led Qty/m(pcs)	48	60
Voltage(DC V)	12/24	12/24
Power(W/m)	4.8	6
CRI(Ra)	-	-
Lumen(Lm)	-	-
PCB Width(mm)	10	10
Cutting unit(mm)	125/250	100/200
CCT		
IP Grade		



30LED WIFI type

LW -5050-30-RGB-12V-WIFI

Picture



Dimension

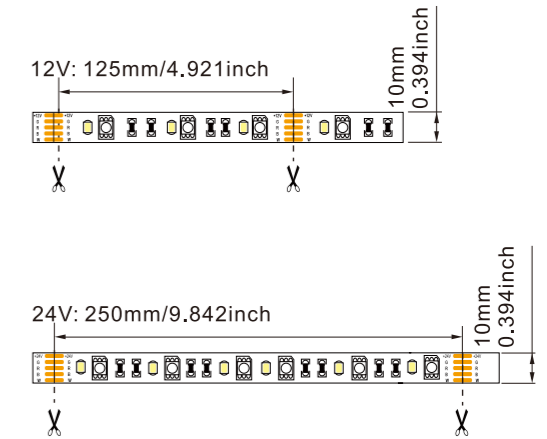

Qualification



Features

- Soft and flexible LED strip .
- Easy installation
- Control the strip lighting with TUYAAPP with multi functions:1 6 million colors, music and mic function, lights color changes with the music beats or your mobile phone.

Parameters

Model	LW -5050-30-RGB-12V-WIFI
Led	SMD5050
Led Qty/m(pcs)	30
Voltage(DC V)	12/24
Power(W/m)	7.2
CRI(Ra)	-
Lumen(Lm)	-
PCB Width(mm)	10
Cutting unit(mm)	125/250
CCT	
IP Grade	



30LED WIFI TUYA type

LW -5050-30-RGB-12V-WIFI TUYA

Picture



Dimension

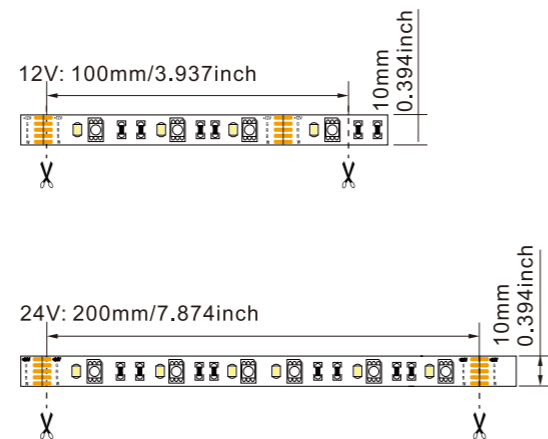

Qualification



Features

- Soft and flexible LED strip
- Easy installation
- Control the strip lighting with TUYAAPP with multi functions:16 million colors, music and mic function, lights color changes with the music beats or your mobile phone.

Parameters

Model	LW -5050-30-RGB-12V-WIFI TUYA
Led	SMD5050
Led Qty/m(pcs)	30
Voltage(DC V)	12/24
Power(W/m)	7.2
CRI(Ra)	-
Lumen(Lm)	-
PCB Width(mm)	10
Cutting unit(mm)	100/200
CCT	R G B
IP Grade	IP20 IP64 IP65 IP68



30LED WIFI TUYA type

LW -5050-30-RGB-12V-WIFI TUYA

Picture



Dimension

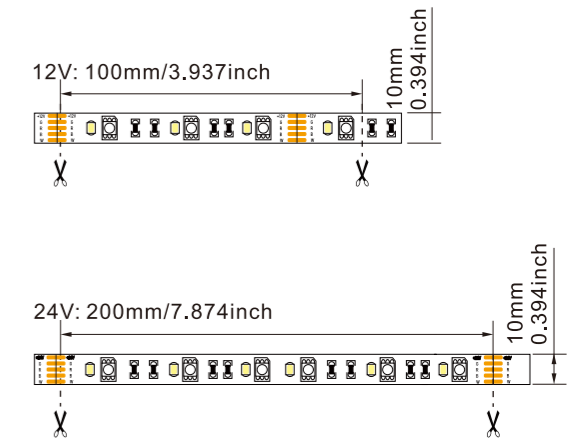

Qualification



Features

- Soft and flexible LED strip
- Easy installation
- Control the strip lighting with TUYAAPP with multi functions:16 million colors, music and mic function, lights color changes with the music beats or your mobile phone.

Parameters

Model	LW -5050-30-RGB-12V-WIFI TUYA
Led	SMD5050
Led Qty/m(pcs)	30
Voltage(DC V)	12/24
Power(W/m)	7.2
CRI(Ra)	-
Lumen(Lm)	-
PCB Width(mm)	10
Cutting unit(mm)	100/200
CCT	R G B
IP Grade	IP20 IP64 IP65 IP68